

Model 8011 High Current Test Socket Kit

Keithley Instruments
28775 Aurora Road
Cleveland, Ohio 44139
1-800-935-5595
<http://www.tek.com/keithley>

Connection Instructions

Model 8011 High Current Test Socket Kit connection instructions

WARNING

Before proceeding, please read, understand, and follow all safety precautions provided at the end of this document.

The Model 8011 is designed for testing high power devices with 2600A Series SourceMeter instruments and the Model 2651A High Power SourceMeter Instrument at currents up at 50 A pulsed and voltages up to 40 V.

The Model 8011 includes two test boards, the 8011-DTB and the 8011-CTB, and cables and connectors for simplifying connections between the SourceMeter instruments and the device. The 8011-DTB Device Test Board is designed for testing type TO-247 packaged parts and axial-lead components. The 8011-CTB Customizable Test Board provides a blank space for user customization — the user can use the socket type of his or her choice.

Figure 1: Model 8011 High Current Test Socket Kit*

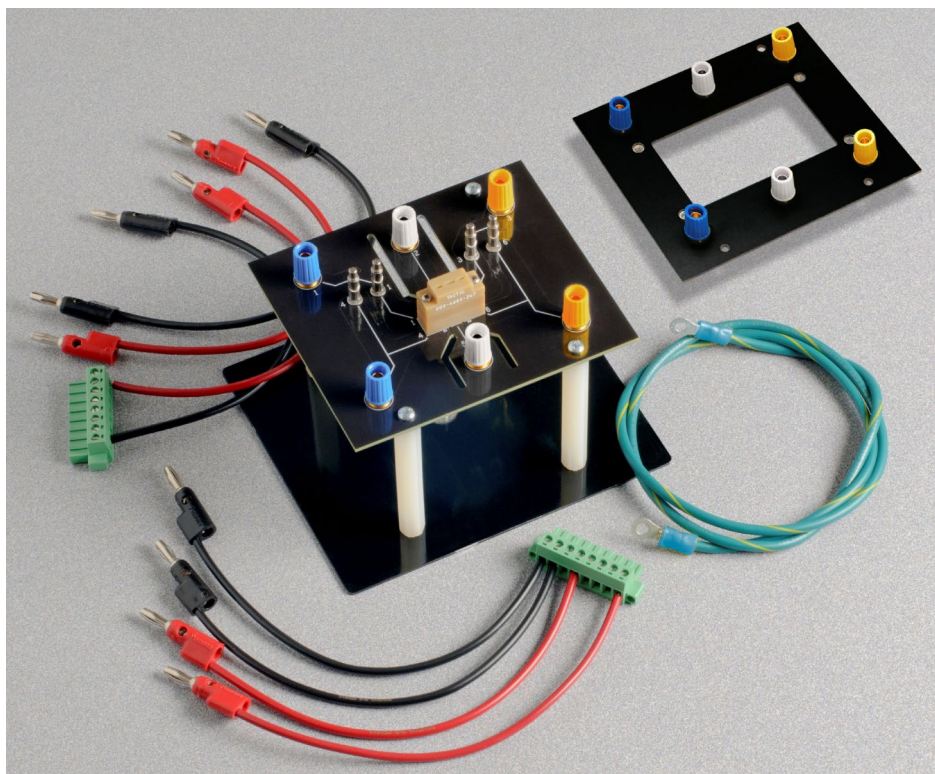

*Not shown: PA-1032 (these instructions); full set of cables; 8010-317 insulator plugs; and 2600-KIT.



Power and environmental specifications

For indoor use only.

Specification	Value
Voltage limit	40 V DC maximum
Current limit	15 A DC maximum

Unpack and inspect the High Current Test Socket Kit

To unpack and inspect the:

1. Inspect the box for damage.
2. Open the top of the box.
3. Remove the bags that contain the boards and accessories.
4. Carefully lift the Model 8010 out of the box.
5. Inspect the materials for any obvious signs of physical damage. Report any damage to the shipping agent immediately.

You should have received:

- TO-247 Device Test Board (8010-120; to re-order, use Keithley Model number 8010-DTB)
- Customizable Test Board (8010-130; to re-order, use Keithley Model number 8010-CTB)
- PA-1032 Connection Instructions (this document)
- Four nylon hex standoffs with inserts on each end (ST-272-1)
- Four Phillips flat-head screws (#6-32 x 3/8)
- Two 8 in. (203.2 mm) stackable banana cables — one black (CA-560-0), one red (CA-560-2)
- One mounting plate (8011-301)
- Two 8-pin female plug connectors with screw terminal connections (CS-1629-8)
- Four 9 in. (228.6 mm) black cables with one stackable banana plug and one unterminated end (CA-567-0)
- Four 9 in. (228.6 mm) red cables with one stackable banana plug and one unterminated end (CA-567-2)
- One 120 in. (304.6 cm) green/yellow ground cable with lugs (CA-568-120)
- One #6-32 Keps® washer nut
- Two insulator plugs (quantity includes a spare plug) (8010-317)
- Two screw terminal connector kits (2600-KIT)

Assembly instructions

NOTE

If you are customizing the 8010-130 Customizable Test Board, make customizations before assembling the Model 8011.

Tools needed

- Medium Phillips head screwdriver
- 5/16 in. nut driver or socket wrench

Assembly instructions

1. Select the TO-247 Device Test Board (8010-120) or Customizable Test Board (8010-130), as appropriate for your application.
2. Connect one end of the ground cable to the ground screw at the center of the mounting plate.
3. Attach the ground cable with the #6-32 Keps® washer nut.
4. Thread the four nylon hex standoffs onto the four threaded posts on the mounting plate.
5. Place the 8010-120 or 8010-130 board on the standoffs.
6. Thread four of the Phillips flat-head screws through the 8010-120 or 8010-130 board.
7. Tighten the screws.
8. Attach the other end of the ground cable to protective earth (ground).

WARNING

The ground wire must be attached to a known safety earth (ground). Failure to attach the ground wire to a known safety earth (ground) may result in electric shock.

Figure 2: Model 8011 assembly

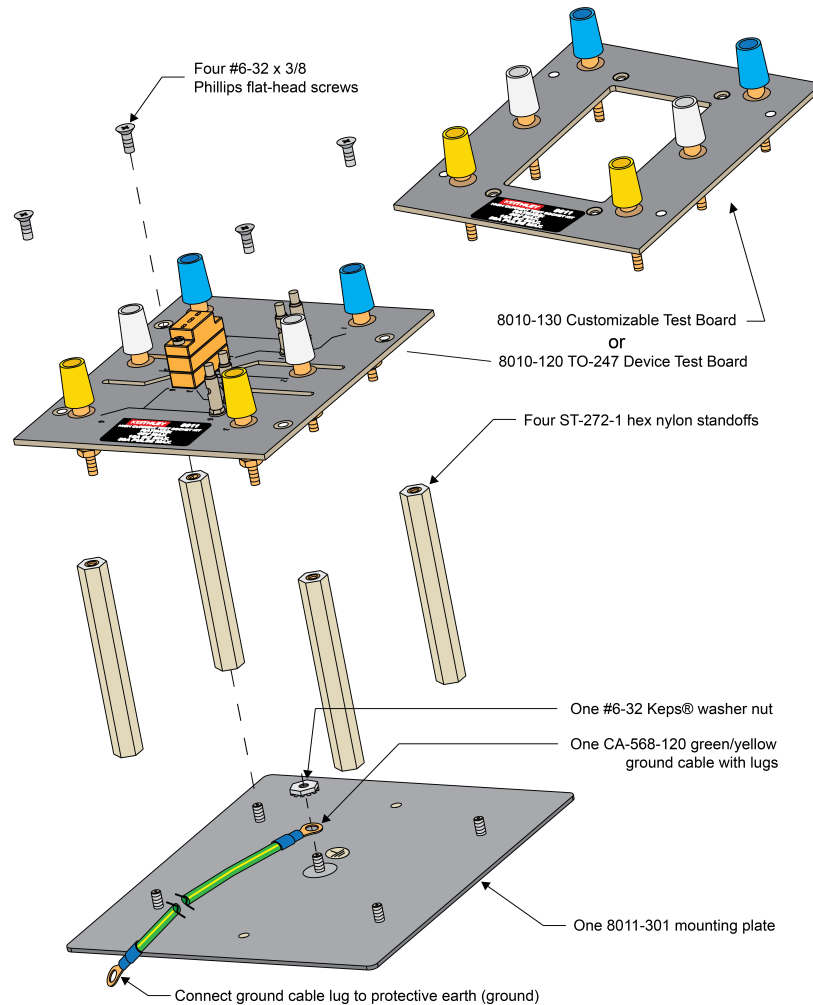

Mounting instructions

The 8011-301 mounting plate should be used to secure your test board (8010-120 or 8010-130). It can also be used to secure the assembled Model 8011 to a work surface using the mounting holes shown in the next figure.

Figure 3: Mounting plate dimensions

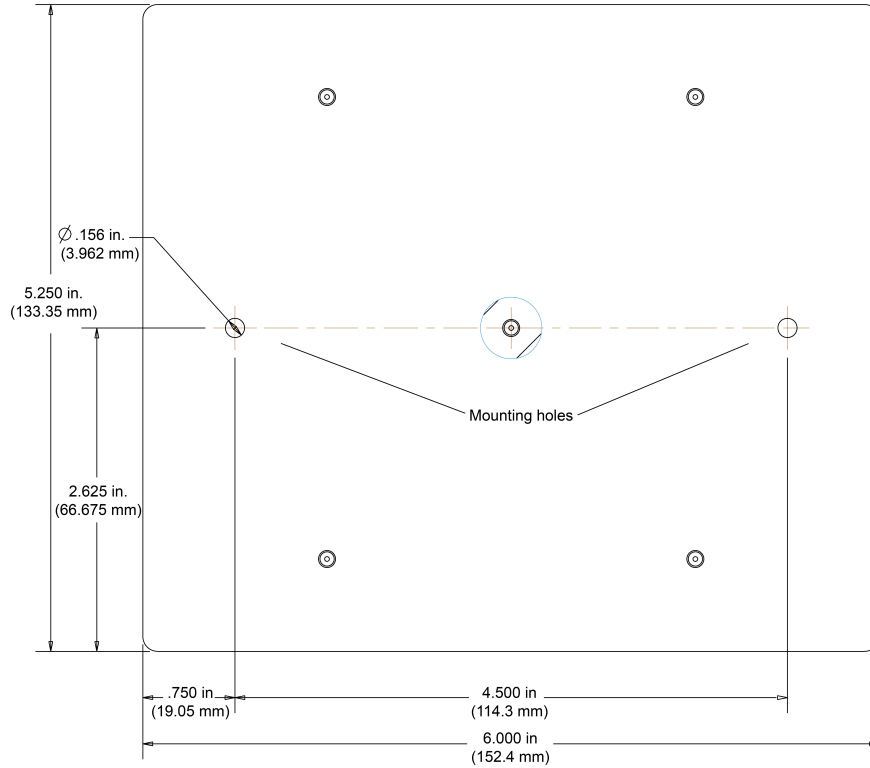

NOTE

You can attach your own test board or testing fixture to the 8010-130 Customizable Test Board using the #6-32 screw mounts provided.

Figure 4: 8010-130 Customizable Test Board dimensions

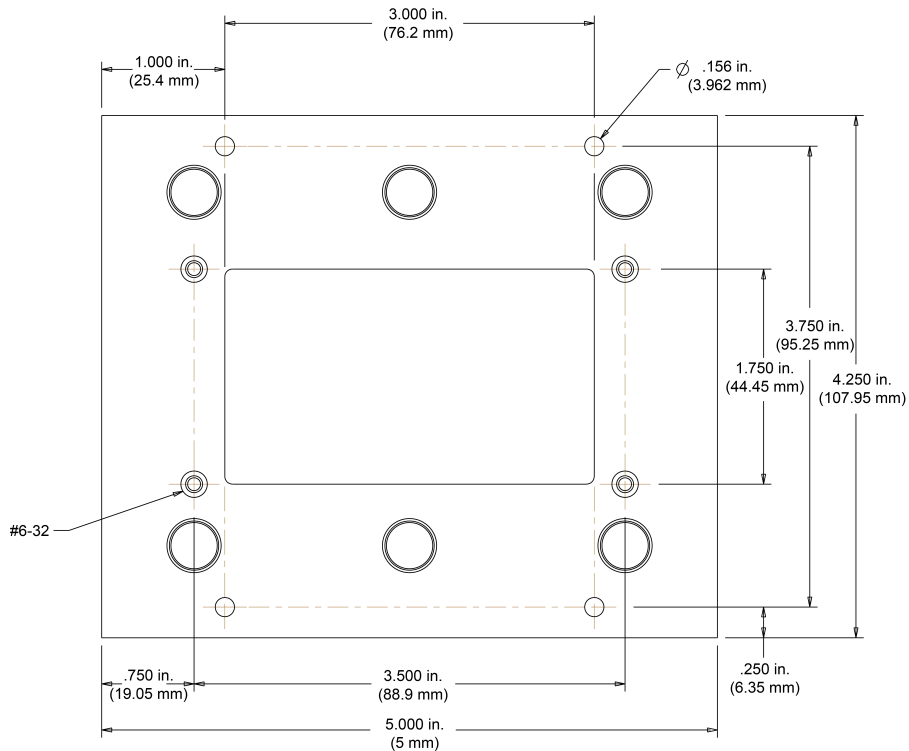

The High Current Test Socket Kit provides several types of connections to allow you to make connections to meet the needs of your application.

In general, when making connections:

- Remove power from the SourceMeter instrument before making connections.
- Make connections to the SourceMeter instrument before making connections to the Model 8011 boards.
- Connect the force leads of the SourceMeter instrument to terminals 4, 5, and 6 of the Model 8011 boards. Connect the sense leads to terminals 1, 2, and 3.
- Install the device under test (DUT) after making the SourceMeter instrument connections.

Use-cases are shown below that demonstrate some typical connections.

Use-cases

Two-terminal DUT using a Model 2651A set to local sense

NOTE

These instructions provide general information about connections to the Model 2651A. For detail on the connections, see the Model 2651A user documentation.

Tools needed

- Small flat-head screwdriver

Instructions

1. Remove power from the Model 2651A.
2. Make connections as shown in the next t and figure.
3. Install the 8010-317 insulator plug into the test socket.
4. Install the 2-terminal DUT into the axial posts labeled 4, 1, 3 and 6 on the 8010-120 board.
5. Return power to the Model 2651A.
6. Press the **CONFIG** key.
7. Press the **SRC** or **MEAS** key (the sense mode can be set from either the V-SOURCE or the V-MEAS menu).
8. If you pressed the SRC key, select **V-SOURCE > SENSE-MODE**.
9. If you pressed the MEAS key, select **V-MEAS > SENSE-MODE**.
10. Select **2-WIRE** to enable local sense.
11. Test the device.

Connections for two-terminal device test (local sense)

Cable end	Cable	Cable end
Model 2651A rear panel	CA-552-1 (supplied with the Model 2651A)	Open
LO of CA-552-1	Black CA-560-0	8010-120 blue terminal 4
HI of CA-552-1	Red CA-560-2	8010-120 yellow terminal 6

NOTE

Do not plug the CA-560-0 and CA-560-2 cables directly into the CA-552-1. Always use the CS-1626-2, as shown in the figure. Plugging the cables directly into the CA-552-1 can permanently damage the connector.

Figure 5: Connections for two-terminal device test (local sense)

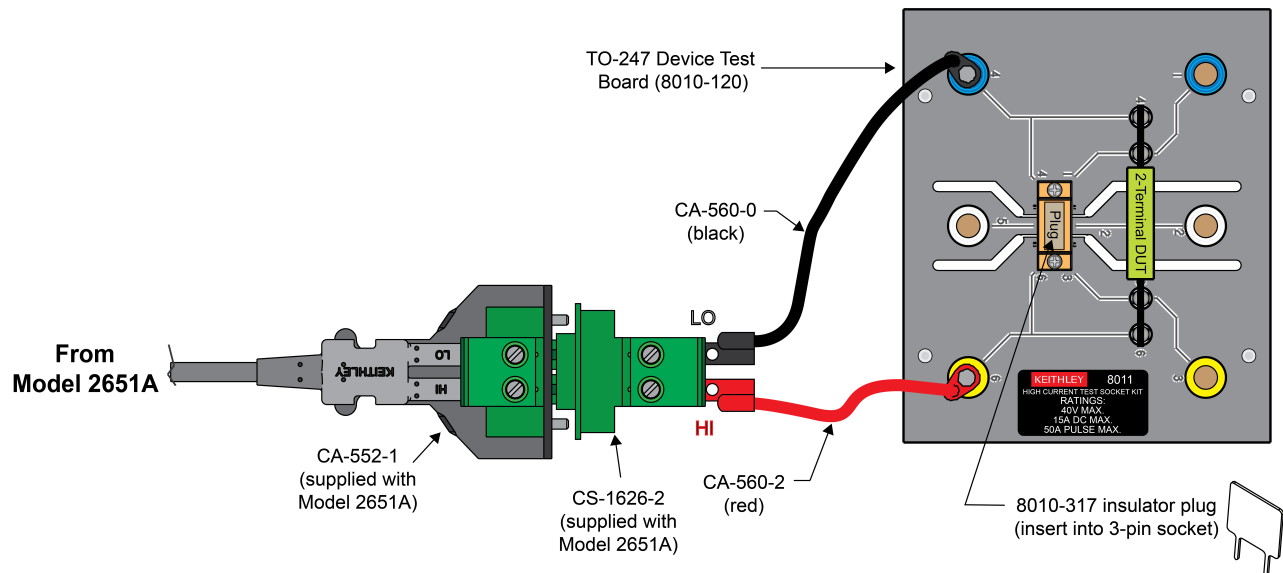

Two-terminal DUT using a Model 2651A set to remote sense

Tools needed

- Small flat-head screwdriver

Instructions

1. Remove power from the Model 2651A.
2. Make connections as shown in the next table and figure.
3. Install the 8010-317 insulator plug into the test socket.
4. Install the 2-terminal DUT into the axial posts labeled 4, 1, 3 and 6 on the 8010-120 board.
5. Return power to the Model 2651A.
6. Press the **CONFIG** key.
7. Press the **SRC** or **MEAS** key (the sense mode can be set from either the V-SOURCE or the V-MEAS menu).
8. If you pressed the SRC key, select **V-SOURCE > SENSE-MODE**.
9. If you pressed the MEAS key, select **V-MEAS > SENSE-MODE**.
10. Select **4-WIRE** to enable remote sense.
11. Test the device.

Connections for two-terminal device test (remote sense)

Cable end	Cable	Cable end
Model 2651A rear panel	CA-552-1 (supplied with the Model 2651A)	Open
LO of CA-552-1	Black CA-560-0	8010-120 blue terminal 4
HI of CA-552-1	Red CA-560-2	8010-120 yellow terminal 6
Model 2651A rear panel	CA-557-1 (supplied with the Model 2651A)	CS-1629-8
Sense LO of CS-1629-8	Black CA-567-0	8010-120 blue terminal 1
Sense HI of CS-1629-8	Red CA-567-2	8010-120 yellow terminal 3

NOTE

Do not plug the CA-560-0 and CA-560-2 cables directly into the CA-552-1. Always use the CS-1626-2, as shown in the figure. Plugging the cables directly into the CA-552-1 can permanently damage the connector.

Figure 6: Connections for two-terminal device test (remote sense)

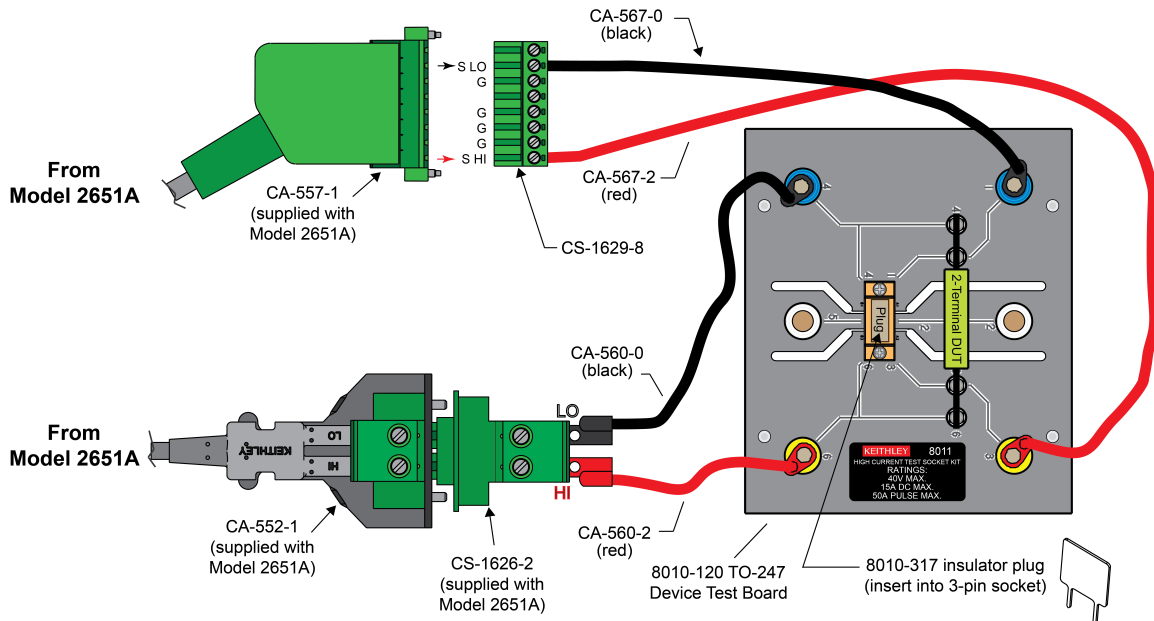

Three-terminal DUT using a Model 2651A and a single or dual channel SourceMeter instrument

NOTE

If you are using a Model 2600A, do not set the output above 40 V. The Model 8011 is rated to 40 V.

You can use the Model 8011 with the 8010-120 board to test a three-terminal device using a Model 2651A High Power System SourceMeter® Instrument and another SourceMeter instrument. This use-case is appropriate for the following SourceMeter instruments:

- Model 2601A Single-Channel System SourceMeter Instrument
- Model 2611A Single-Channel System SourceMeter Instrument (200 V)
- Model 2602A Dual-Channel System SourceMeter Instrument
- Model 2612A Dual-Channel System SourceMeter Instrument (200 V)

Tools and equipment needed

- Small flat-head screwdriver
- Cable created using the 2600-KIT screw terminal connector kits (included with the Model 8011); the cable must use wire that can support 3 A and 200 V

Instructions

1. Remove power from the SourceMeter instruments.
2. Make connections as shown in the next table and figure.
3. Install the three-terminal DUT into the socket on the 8010-120 board.
4. Return power to the SourceMeter instruments.
5. On both SourceMeter Instruments:
 - a. Press the **CONFIG** key.
 - b. Press the **SRC** or **MEAS** key (the sense mode can be set from either the V-SOURCE or the V-MEAS menu).
 - c. If you pressed the SRC key, select **V-SOURCE > SENSE-MODE**.
 - d. If you pressed the MEAS key, select **V-MEAS > SENSE-MODE**.
 - e. Select **4-WIRE** to enable remote sense.
6. Test the device.

Connections for three-terminal device test

Cable end	Cable	Cable end
Model 2651A rear panel	CA-552-1 (supplied with the Model 2651A)	Open
Model 2651A rear panel	CA-557-1 (supplied with the Model 2651A)	CS-1629-8
Series 2600A rear panel	CA-557-x (recommended; separately purchased)	CS-1629-8
LO of CA-552-1	Black CA-560-0	8010-120 yellow terminal 6
HI of CA-552-1	Red CA-560-2	8010-120 white terminal 5
Sense LO of CS-1629-8	Black CA-567-0	8010-120 yellow terminal 3
Sense HI of CS-1629-8	Red CA-567-2	8010-120 white terminal 2
Sense LO of CS-1629-8	Black CA-567-0	8010-120 yellow terminal 3
LO of CS-1629-8	Black CA-567-0	8010-120 yellow terminal 3
Sense HI of CS-1629-8	Red CA-567-2	8010-120 blue terminal 1
HI of CS-1629-8	Red CA-567-2	8010-120 blue terminal 4

NOTE

Do not plug the CA-560-0 and CA-560-2 cables directly into the CA-552-1. Always use the CS-1626-2, as shown in the figure. Plugging the cables directly into the CA-552-1 can permanently damage the connector.

Figure 7: Connections for three-terminal device test

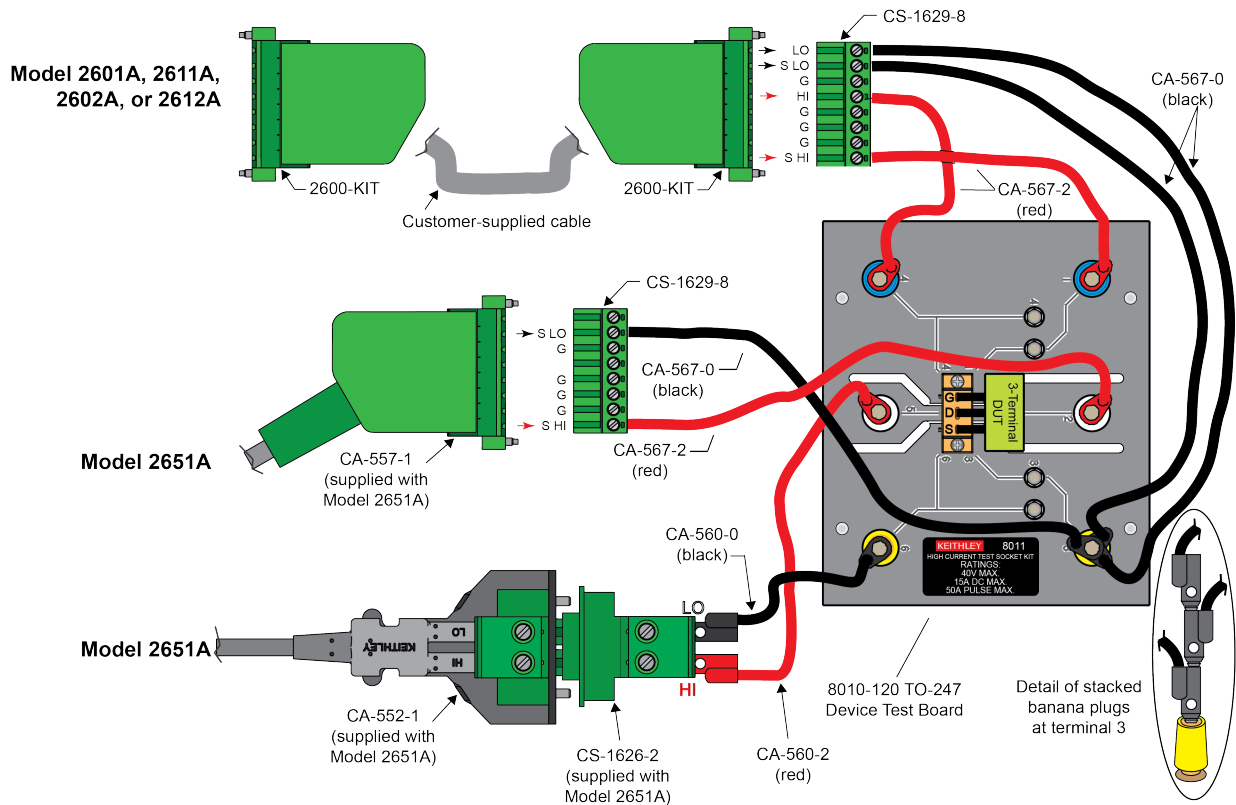

Three-terminal DUT using a Model 2651A and a low current SourceMeter instrument

NOTE

Do not set the Model 2635A or Model 2636A above 40 V. The Model 8011 is rated to 40 V.

You can use the Model 8011 with the 8010-120 board to test a three-terminal device using a Model 2651A High Power System SourceMeter® Instrument and a low-current SourceMeter instrument. This use case is appropriate for the following SourceMeter instruments:

- Model 2635A Single-Channel System SourceMeter Instrument (1 fA, 10 A Pulse)
- Model 2636A Dual-Channel System SourceMeter Instrument (1 fA, 10 A Pulse)

Tools needed

- Small flat-head screwdriver

NOTE

This use case calls for three 2600-ALG-2 cables. Normally, the Model 2635A ships with one of these cables and the Model 2636A ships with two. For additional cables, order Keithley Instruments catalog number 2600-ALG-2. This cable is listed as part number 237-308-2 on Model 2635A and 2636A parts lists.

To set up a test of a three-terminal device:

1. Remove power from the SourceMeter instruments.
2. Make connections as shown in the next table and figure.
3. Install the three-terminal DUT into the socket on the 8010-120 board.
4. Return power to the SourceMeter instruments.
5. On both SourceMeter Instruments:
 - a. Press the **CONFIG** key.
 - b. Press the **SRC** or **MEAS** key (the sense mode can be set from either the V-SOURCE or the V-MEAS menu).
 - c. If you pressed the SRC key, select **V-SOURCE > SENSE-MODE**.
 - d. If you pressed the MEAS key, select **V-MEAS > SENSE-MODE**.
 - e. Select **4-WIRE** to enable remote sense.
6. Test the device.

Connections for three-terminal device test

Cable end	Cable	Cable end
Model 2651A rear panel	CA-552-1 (supplied with the Model 2651A)	Open
Model 2651A rear panel	CA-557-1 (supplied with the Model 2651A)	CS-1629-8
Model 2635A or Model 2636A rear panel Sense HI	2600-ALG-2	Red alligator clip to 8010-120 blue terminal 1
Model 2635A or Model 2636A rear panel HI	2600-ALG-2	Red alligator clip to 8010-120 blue terminal 4
Model 2635A or Model 2636A rear panel Sense LO	2600-ALG-2	Red and black alligator clips to 8010-120 yellow terminal 3
LO of CA-552-1	Black CA-560-0	8010-120 yellow terminal 6
HI of CA-552-1	Red CA-560-2	8010-120 white terminal 5
Sense LO of CS-1629-8	Black CA-567-0	8010-120 yellow terminal 3
Sense HI of CS-1629-8	Red CA-567-2	8010-120 white terminal 2

Figure 8: Connections for three-terminal device test

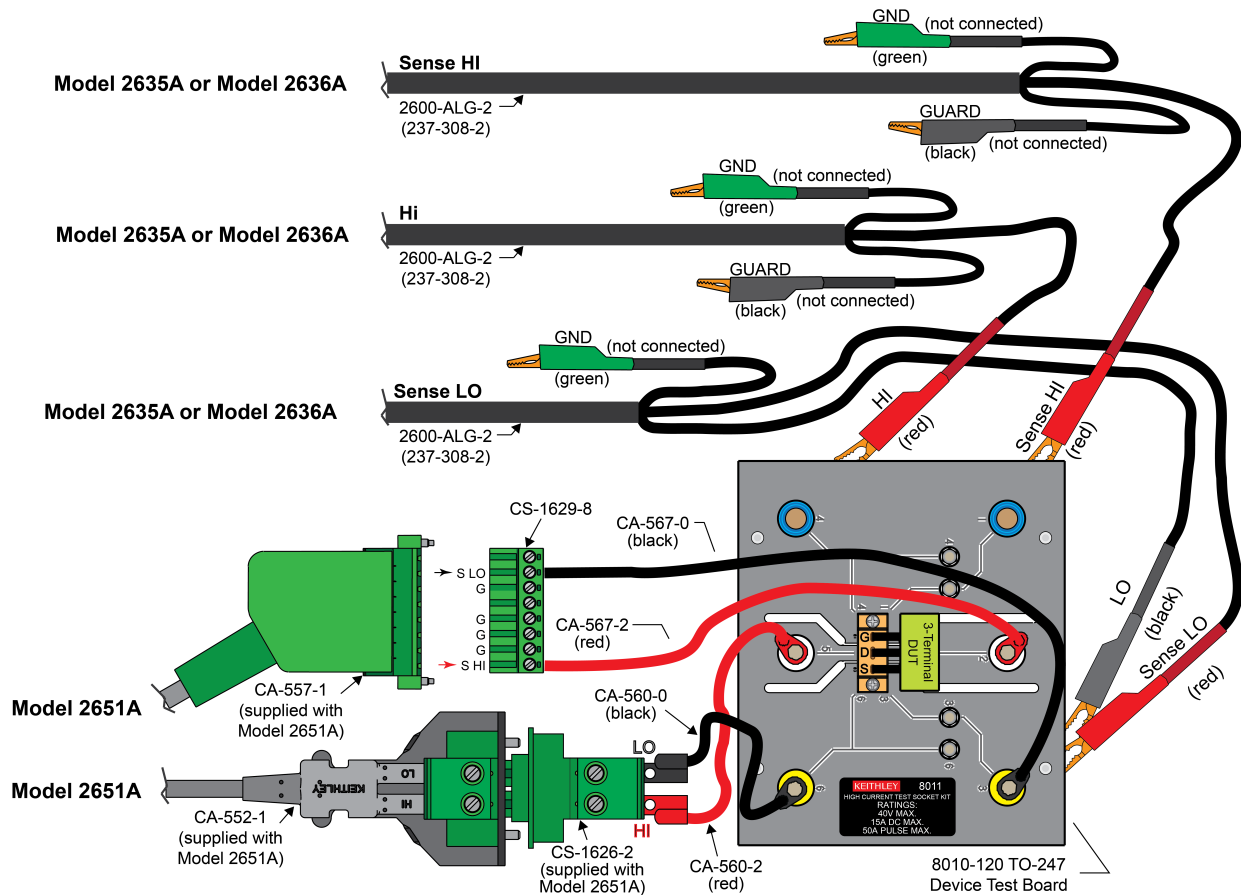

NOTE

Alligator clips are connected the screw posts on the underside of the board, as shown here.

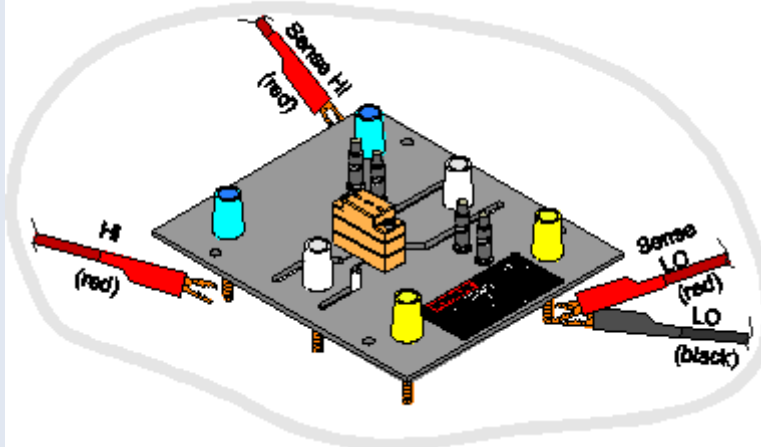

Contact information

If you have any questions after you review the information in this documentation, please contact your local Keithley Instruments office, sales partner, or distributor. You can also call the corporate headquarters of Keithley Instruments (toll-free inside the U.S. and Canada only) at 1-800-935-5595, or from outside the U.S. at +1-440-248-0400. For worldwide contact numbers, visit the Keithley Instruments website (<http://www.tek.com/keithley>).

Safety precautions

WARNING

The 8011 High Current Test Socket Kit is designed to work exclusively with the 2651A High Power System SourceMeter® Instrument and should never be connected to voltage sources that may exceed 40 V DC. The socket should be used within a comprehensive test system (for example, a protective enclosure or safety barrier) that provides adequate safety measures to prevent hazards such as accessible voltage, fire and explosion from causing harm.

The following safety precautions should be observed before using this product and any associated instrumentation. Although some instruments and accessories would normally be used with nonhazardous voltages, there are situations where hazardous conditions may be present.

This product is intended for use by qualified personnel who recognize shock hazards and are familiar with the safety precautions required to avoid possible injury. Read and follow all installation, operation, and maintenance information carefully before using the product. Refer to the user documentation for complete product specifications.

If the product is used in a manner not specified, the protection provided by the product warranty may be impaired.

The types of product users are:

Responsible body is the individual or group responsible for the use and maintenance of equipment, for ensuring that the equipment is operated within its specifications and operating limits, and for ensuring that operators are adequately trained.

Operators use the product for its intended function. They must be trained in electrical safety procedures and proper use of the instrument. They must be protected from electric shock and contact with hazardous live circuits.

Maintenance personnel perform routine procedures on the product to keep it operating properly, for example, setting the line voltage or replacing consumable materials. Maintenance procedures are described in the user documentation. The procedures explicitly state if the operator may perform them. Otherwise, they should be performed only by service personnel.

Service personnel are trained to work on live circuits, perform safe installations, and repair products. Only properly trained service personnel may perform installation and service procedures.

Keithley Instruments products are designed for use with electrical signals that are measurement, control, and data I/O connections, with low transient overvoltages, and must not be directly connected to mains voltage or to voltage sources with high transient overvoltages. Measurement Category II (as referenced in IEC 60664) connections require protection for high transient overvoltages often associated with local AC mains connections. Certain Keithley Instruments measuring instruments may be connected to mains. These instruments will be marked as category II or higher.

Unless explicitly allowed in the specifications, operating manual, and instrument labels, do not connect any instrument to mains.

Exercise extreme caution when a shock hazard is present. Lethal voltage may be present on cable connector jacks or test fixtures. The American National Standards Institute (ANSI) states that a shock hazard exists when voltage levels greater than 30 V RMS, 42.4 V peak, or 60 VDC are present. A good safety practice is to expect that hazardous voltage is present in any unknown circuit before measuring.

Operators of this product must be protected from electric shock at all times. The responsible body must ensure that operators are prevented access and/or insulated from every connection point. In some cases, connections must be exposed to potential human contact. Product operators in these circumstances must be trained to protect themselves from the risk of electric shock. If the circuit is capable of operating at or above 1000 V, no conductive part of the circuit may be exposed.

Do not connect switching cards directly to unlimited power circuits. They are intended to be used with impedance-limited sources. NEVER connect switching cards directly to AC mains. When connecting sources to switching cards, install protective devices to limit fault current and voltage to the card.

Before operating an instrument, ensure that the line cord is connected to a properly-grounded power receptacle. Inspect the connecting cables, test leads, and jumpers for possible wear, cracks, or breaks before each use.

When installing equipment where access to the main power cord is restricted, such as rack mounting, a separate main input power disconnect device must be provided in close proximity to the equipment and within easy reach of the operator.

For maximum safety, do not touch the product, test cables, or any other instruments while power is applied to the circuit under test. ALWAYS remove power from the entire test system and discharge any capacitors before: connecting or disconnecting cables or jumpers, installing or removing switching cards, or making internal changes, such as installing or removing jumpers.

Do not touch any object that could provide a current path to the common side of the circuit under test or power line (earth) ground. Always make measurements with dry hands while standing on a dry, insulated surface capable of withstanding the voltage being measured.

For safety, instruments and accessories must be used in accordance with the operating instructions. If the instruments or accessories are used in a manner not specified in the operating instructions, the protection provided by the equipment may be impaired.

Do not exceed the maximum signal levels of the instruments and accessories. Maximum signal levels are defined in the specifications and operating information and shown on the instrument panels, test fixture panels, and switching cards.

When fuses are used in a product, replace with the same type and rating for continued protection against fire hazard.

Chassis connections must only be used as shield connections for measuring circuits, NOT as protective earth (safety ground) connections.

If you are using a test fixture, keep the lid closed while power is applied to the device under test. Safe operation requires the use of a lid interlock.

If a  screw is present, connect it to protective earth (safety ground) using the wire recommended in the user documentation.

The  symbol on an instrument means caution, risk of danger. The user must refer to the operating instructions located in the user documentation in all cases where the symbol is marked on the instrument.

The  symbol on an instrument means caution, risk of electric shock. Use standard safety precautions to avoid personal contact with these voltages.

The  symbol on an instrument shows that the surface may be hot. Avoid personal contact to prevent burns.

The  symbol indicates a connection terminal to the equipment frame.

If this  symbol is on a product, it indicates that mercury is present in the display lamp. Please note that the lamp must be properly disposed of according to federal, state, and local laws.

The **WARNING** heading in the user documentation explains dangers that might result in personal injury or death. Always read the associated information very carefully before performing the indicated procedure.

The **CAUTION** heading in the user documentation explains hazards that could damage the instrument. Such damage may invalidate the warranty.

Instrumentation and accessories shall not be connected to humans.

Before performing any maintenance, disconnect the line cord and all test cables.

To maintain protection from electric shock and fire, replacement components in mains circuits — including the power transformer, test leads, and input jacks — must be purchased from Keithley Instruments. Standard fuses with applicable national safety approvals may be used if the rating and type are the same. The detachable mains power cord provided with the instrument may only be replaced with a similarly rated power cord. Other components that are not safety-related may be purchased from other suppliers as long as they are equivalent to the original component (note that selected parts should be purchased only through Keithley Instruments to maintain accuracy and functionality of the product). If you are unsure about the applicability of a replacement component, call a Keithley Instruments office for information.

Unless otherwise noted in product-specific literature, Keithley Instruments are designed to operate indoors only, in the following environment: Altitude at or below 2,000 m (6,562 ft); temperature 0 °C to 50 °C (32 °F to 122 °F); and pollution degree 1 or 2.

To clean an instrument, use a damp cloth or mild, water-based cleaner. Clean the exterior of the instrument only. Do not apply cleaner directly to the instrument or allow liquids to enter or spill on the instrument. Products that consist of a circuit board with no case or chassis (e.g., a data acquisition board for installation into a computer) should never require cleaning if handled according to instructions. If the board becomes contaminated and operation is affected, the board should be returned to the factory for proper cleaning/servicing.

Safety precaution revision as of March 2016.